



FEATURES

High-Precision SMT DC-DC Circuit Design | Ensures full output of 12V circuit | Double-layer fiberglass PCB circuit | Flat copper filter inductor



AC650 FULL MODULAR POWER SUPPLY



SPECIFICATIONS

Rated Power	650W (Full Modular)
Voltage	220V
Main Features	Active APFC+DC-DC
Efficiency	80PLUS Bronze Certification
Temperature Control	Supported
Protections	Overvoltage/undervoltage Protection, Short Circuit Protection, Overload Protection
Warranty	5 years
Packaging Accessories	Screw package, Manual, Power Cord

CONNECTORS

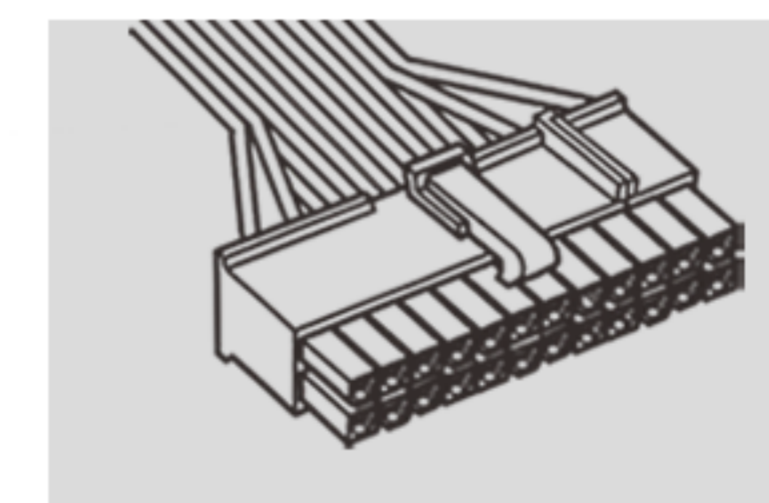

1x (20+4PIN)

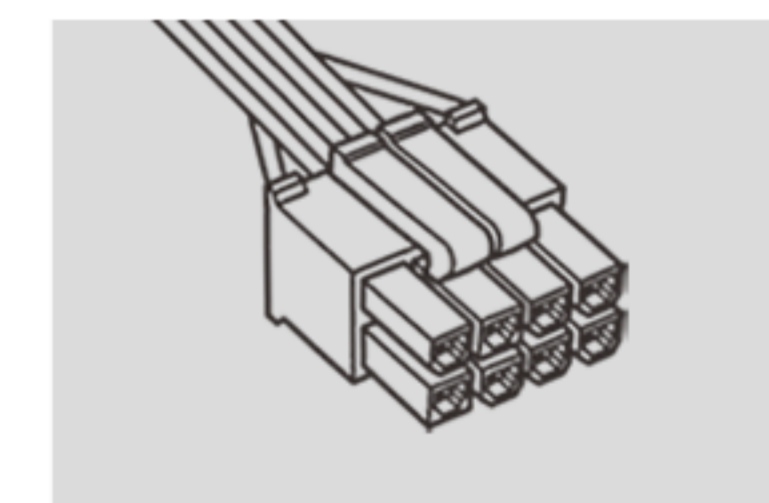

2x (P4+4)

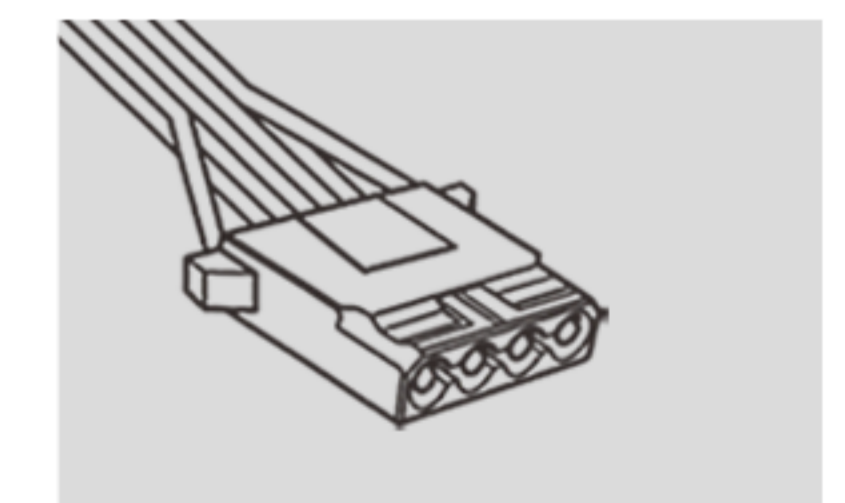

3x Large 4PIN

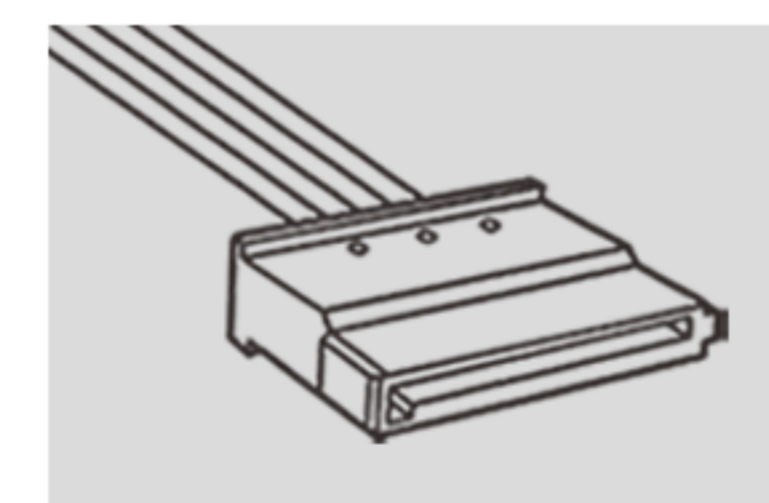

5x SATA

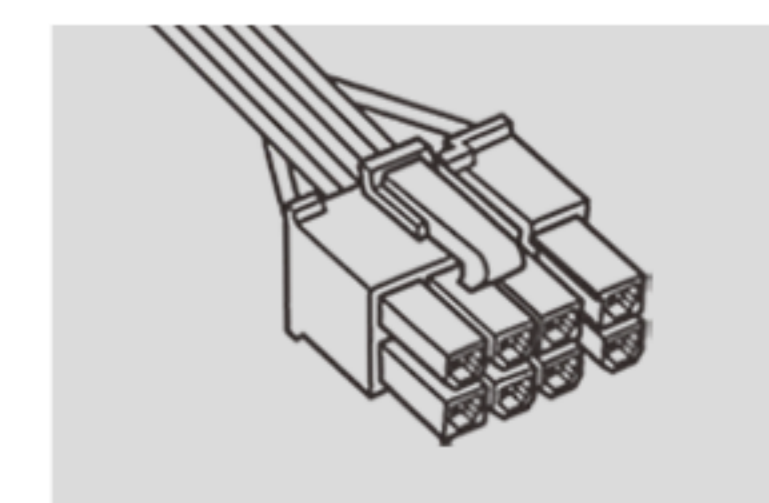

2x (P6+2)